

\*available space for mounting, cables, sockets etc. space not available behind driverbox and length crossbar

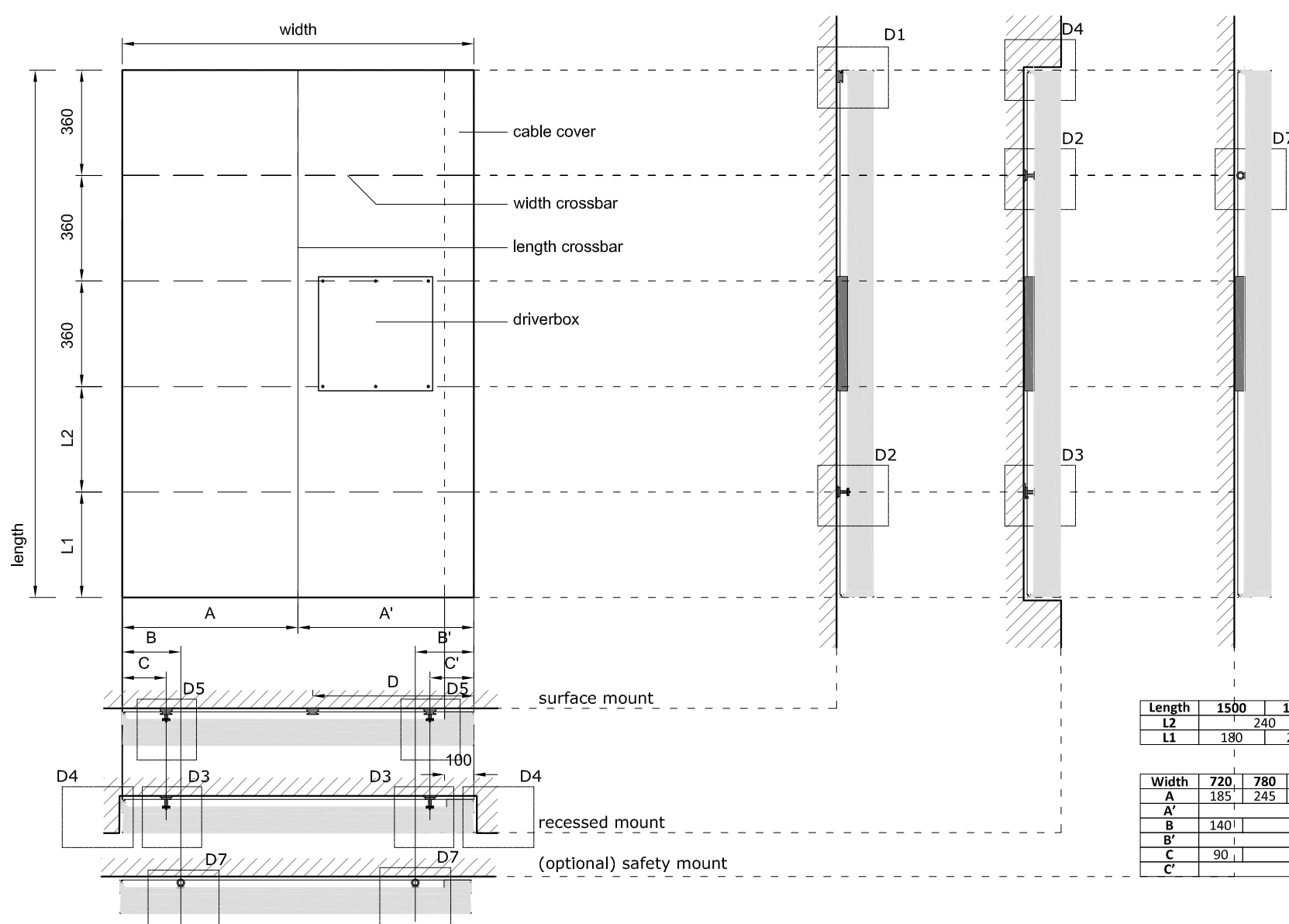

Length	1500	1560	1620	1680	1740	1800
L2	240				360	
L1	180	240	180	240	300	360

Width	720	780	840	900	960	1020	1080	1140	1200
A	185	245	305	365	425	485	545	570	600
A'				535				570	600
B	140				200				
B'					200				
C	90				150				
C'					150				

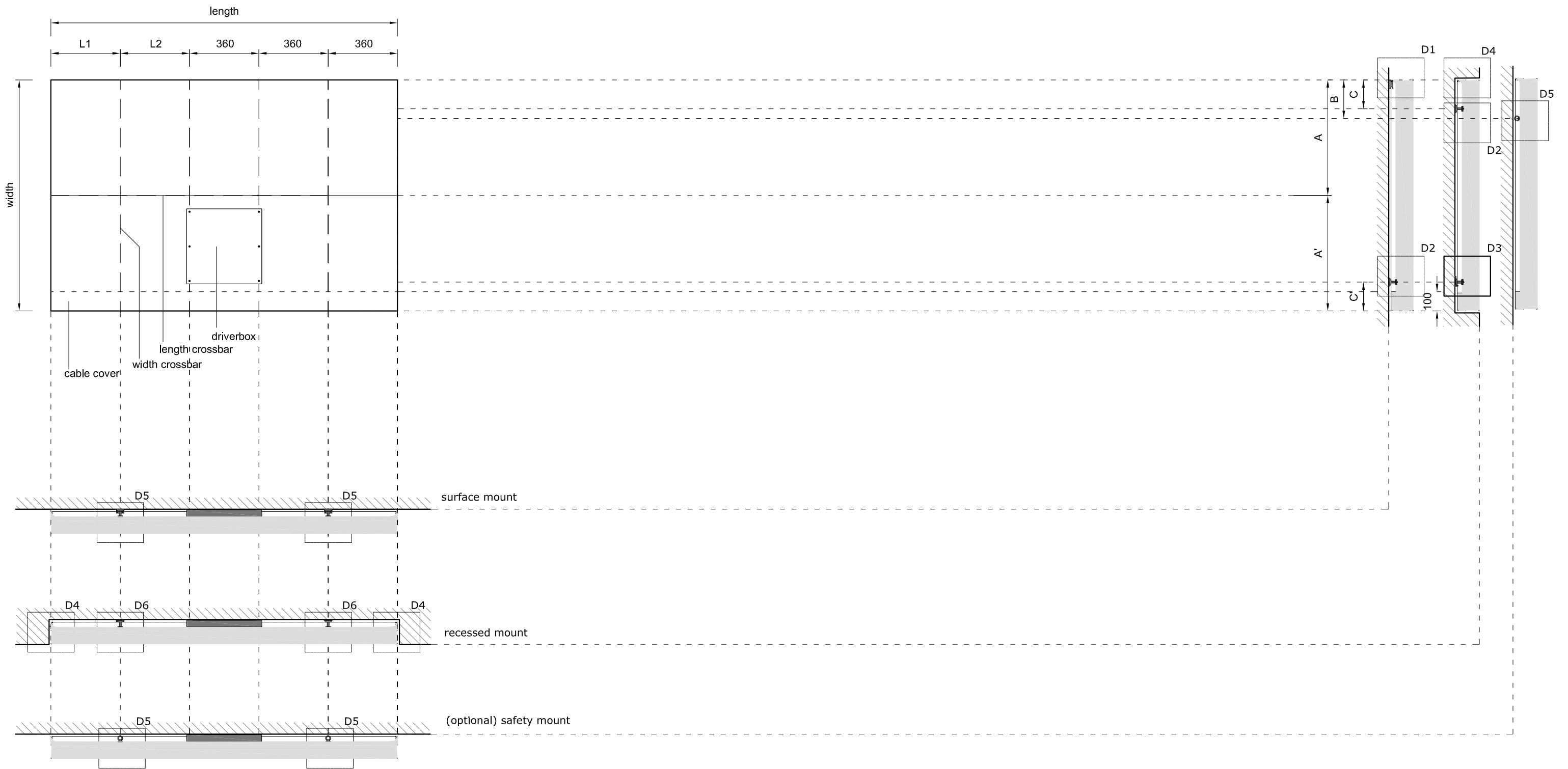

panel height

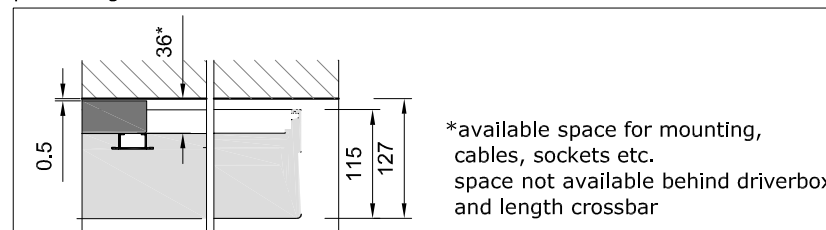

Length	1500	1560	1620	1680	1740	1800
L2	240			360		
L1	180	240	180	240	300	360

Width	720	780	840	900	960	1020	1080	1140	1200
A	185	245	305	365	425	485	545	570	600
A'				535				570	600
B	140			200					
B'				200					
C	90			150					
C'				150					

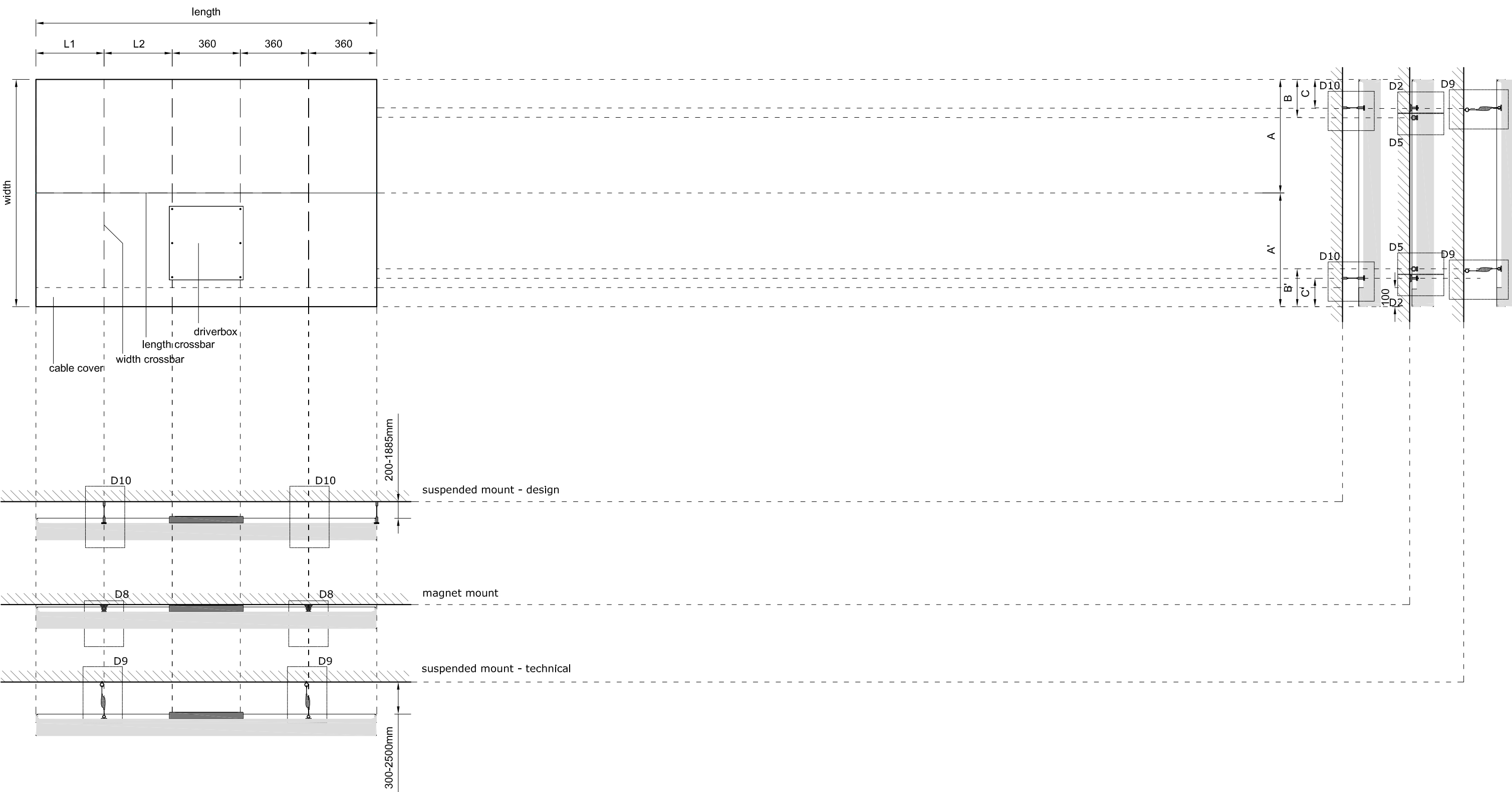

panel height

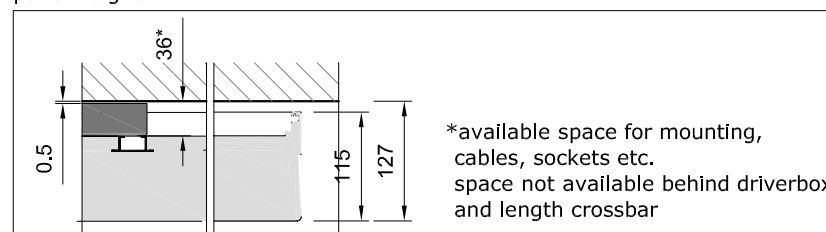

Length	1500	1560	1620	1680	1740	1800
L2	240					
L1	180	240	180	240	300	360

Width	720	780	840	900	960	1020	1080	1140	1200	
A	185	245	305	365	425	485	545	570	600	
A'	535								570	600
B	140	200								
B'	200									
C	90	150								
C'	150									

D1: wall hook

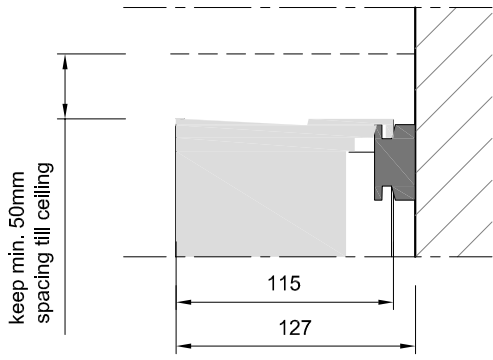

D2: magnet + plate

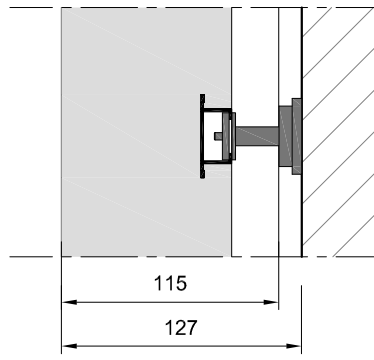

D3: magnet + L-bracket

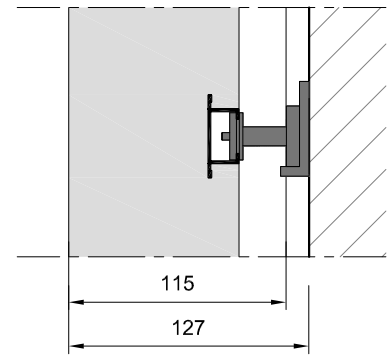

D4: recessed mounting - clearance

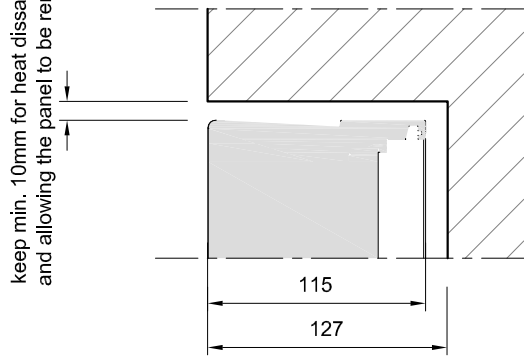

D5: wall hook / magnet + plate

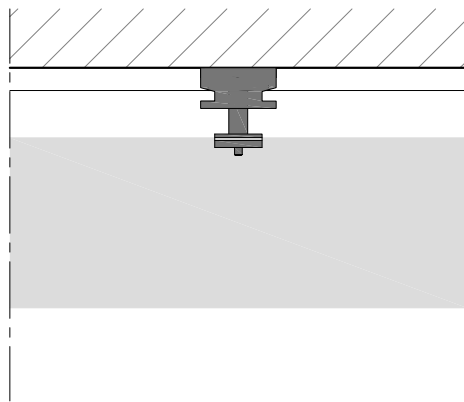

D6: magnet + plate / magnet + L-bracket

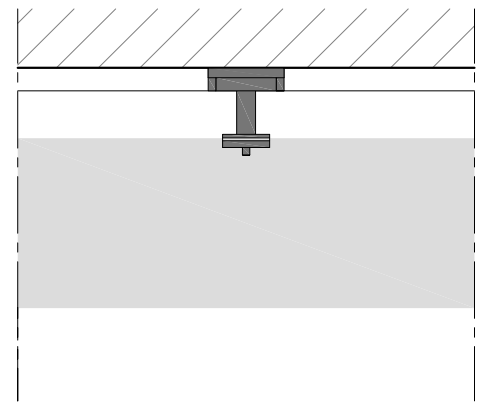

D7: safety eye

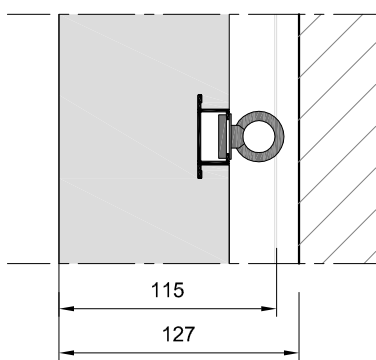

ensure wall safety eye is not exactly behind the panel safety eye

D8: magnet + plate / safety eye

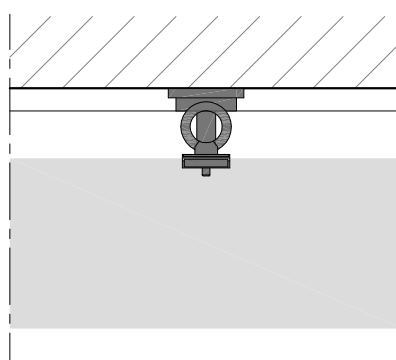

ensure ceiling safety eye is not exactly behind the panel safety eye

D9: technical suspended

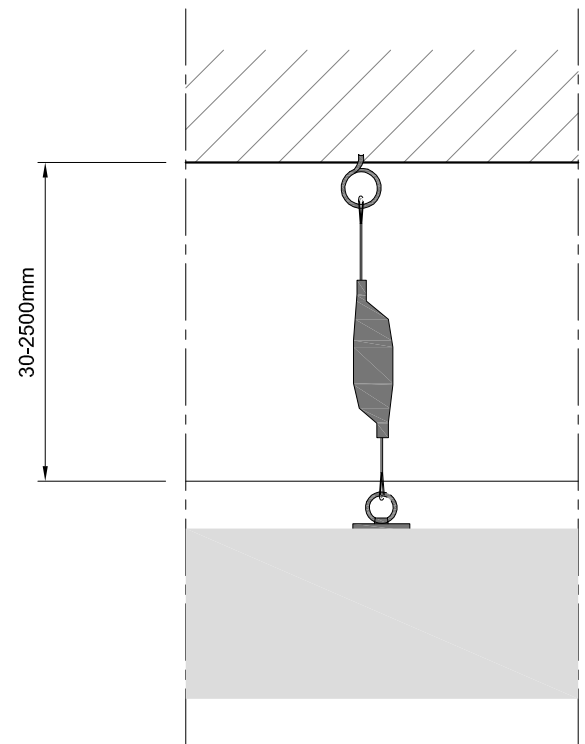

D10: posilock suspended

