

*available space for mounting, cables, sockets etc. space not available behind driverbox and length crossbar

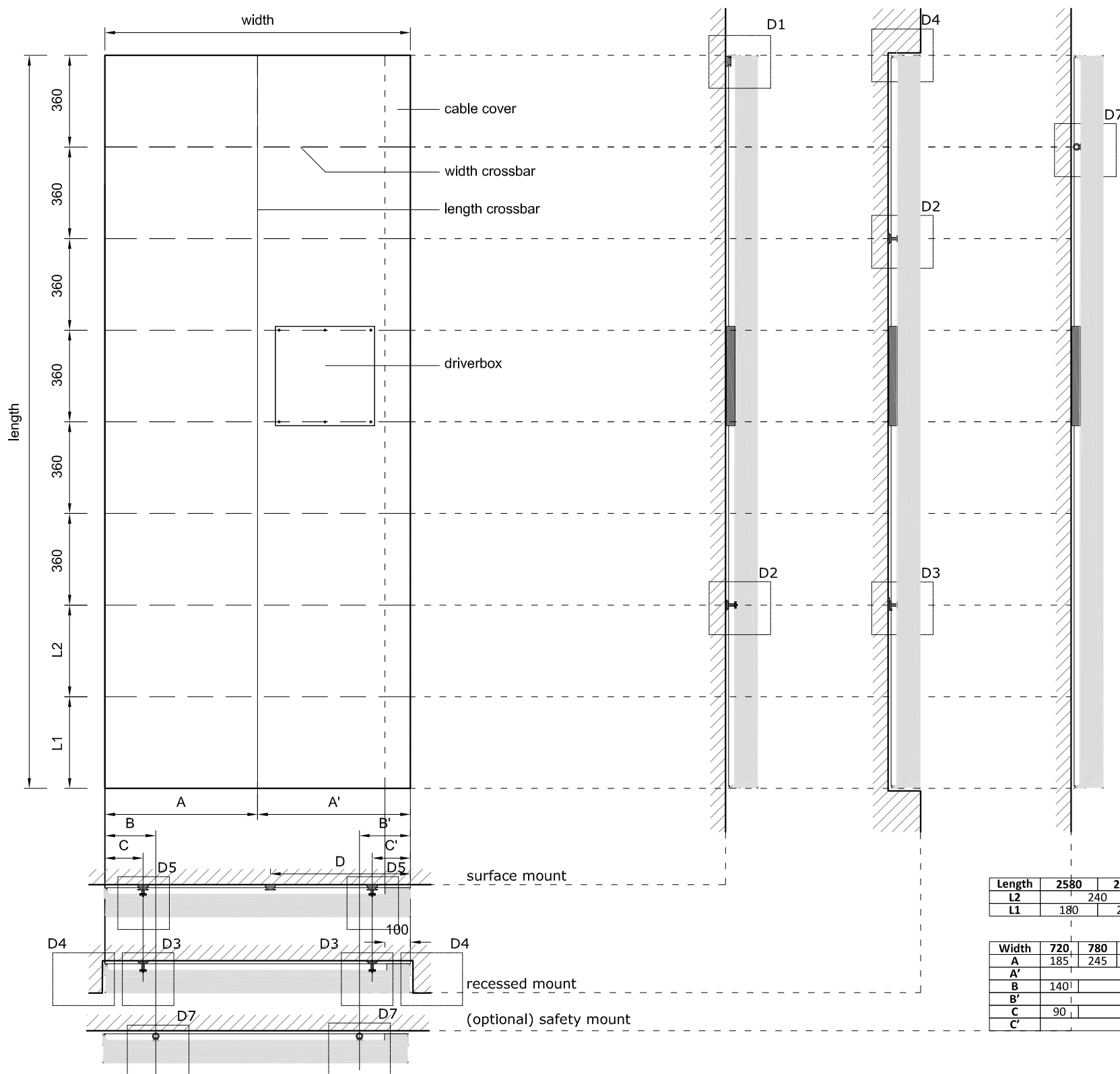

Length	2580	2640	2700	2760	2820	2880
L2	240	360				
L1	180	240	180	240	300	360

Width	720	780	840	900	960	1020	1080	1140	1200
A	185	245	305	365	425	485	545	570	600
A'				535					
B	140					200			
B'						200			
C	90					150			
C'						150			

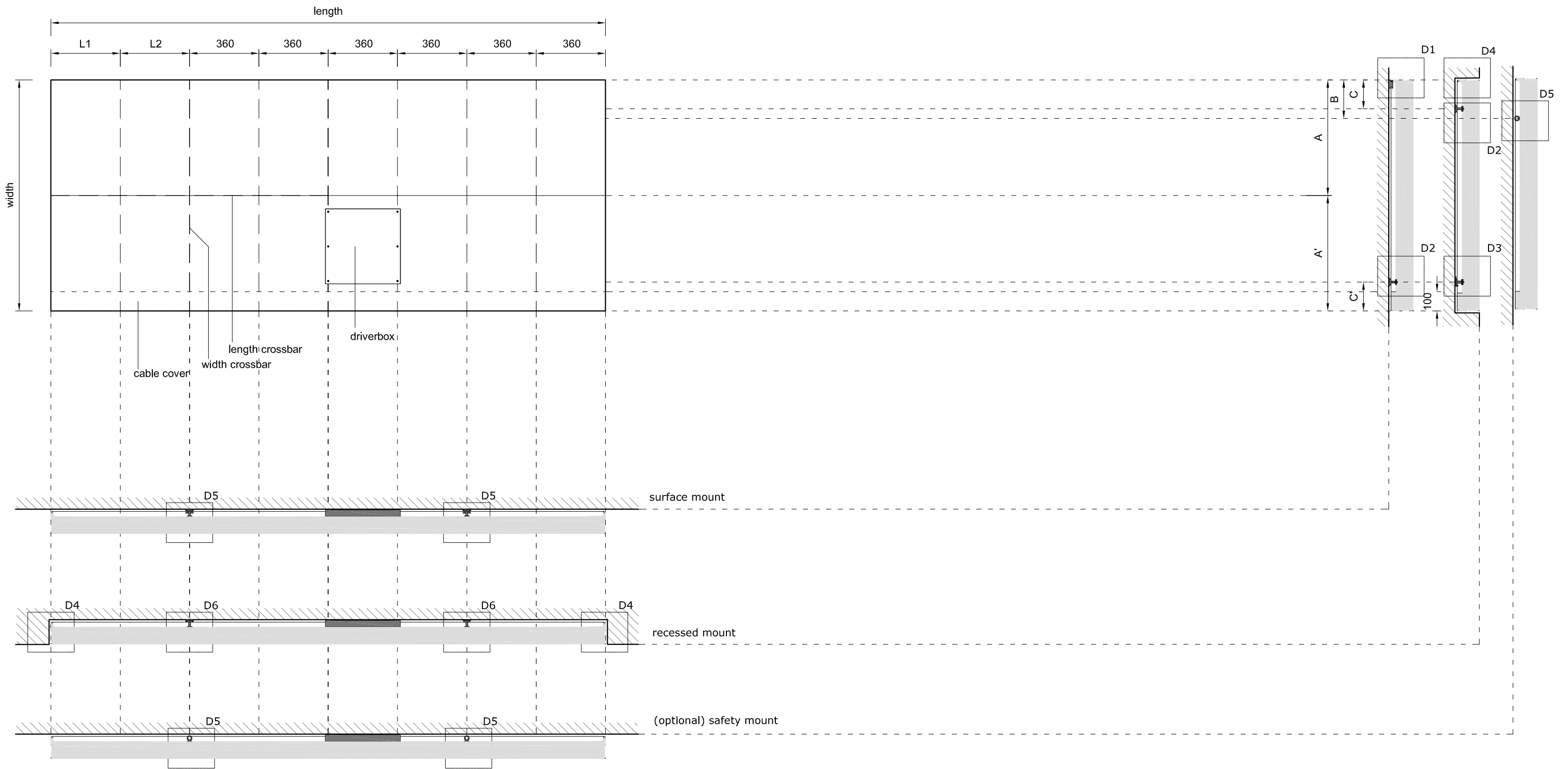

panel height

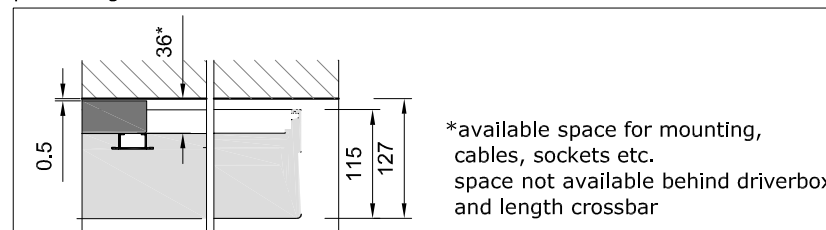

Length	2580	2640	2700	2760	2820	2880
L2	240			360		
L1	180	240	180	240	300	360

Width	720	780	840	900	960	1020	1080	1140	1200
A	185	245	305	365	425	485	545	570	600
A'				535				570	600
B	140				200				
B'					200				
C	90				150				
C'					150				

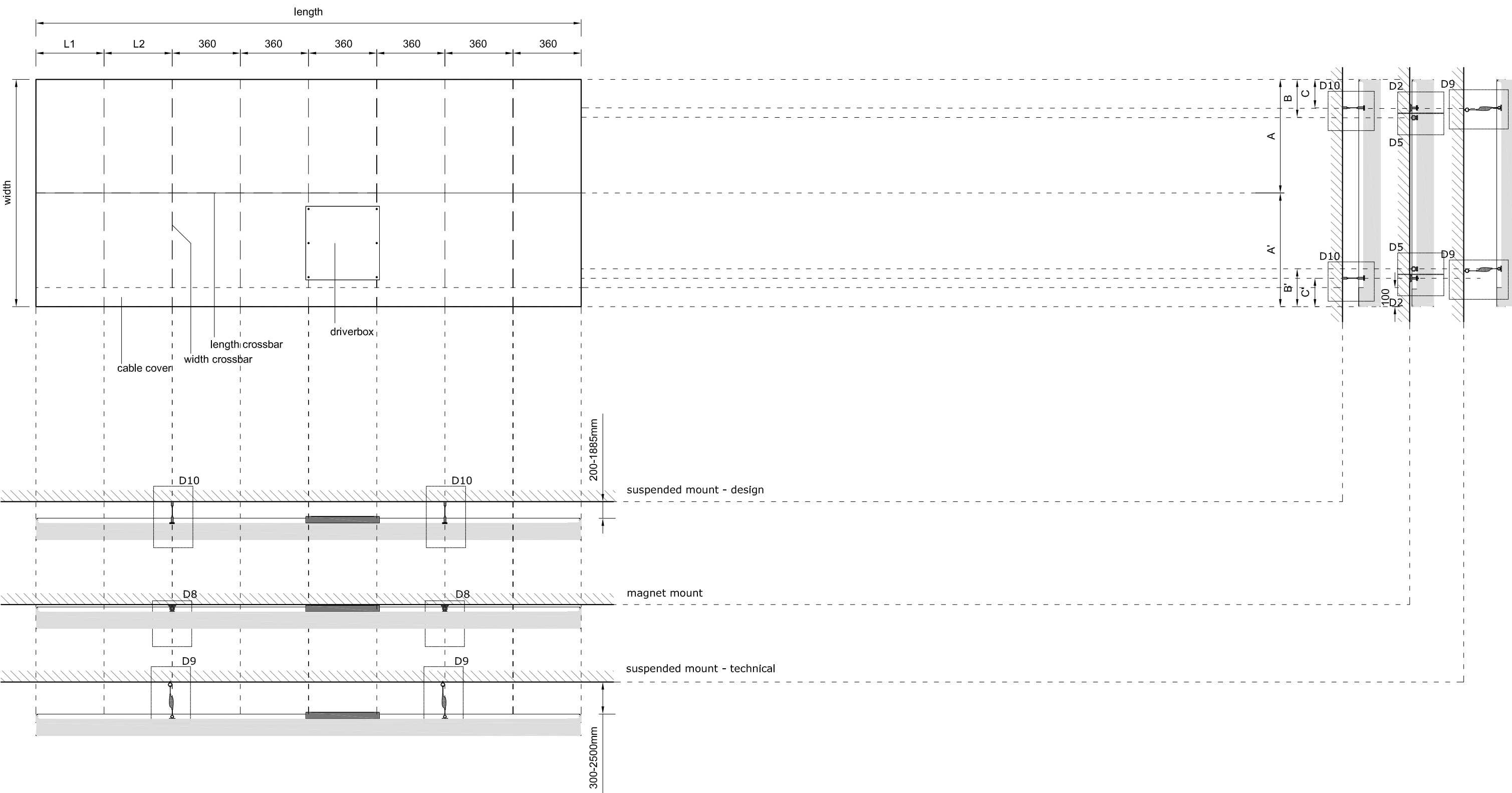

Length	2580	2640	2700	2760	2820	2880
L2	240	240	240	240	360	360
L1	180	240	180	240	300	360

Width	720	780	840	900	960	1020	1080	1140	1200	
A	185	245	305	365	425	485	545	570	600	
A'	535								570	600
B	140	200								
B'	200									
C	90	150								
C'	150									

panel height

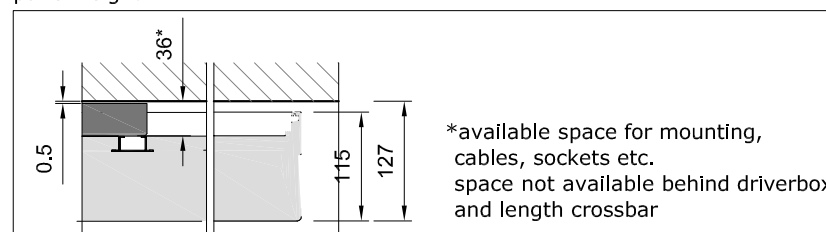

2580-2880 mm ceiling mount

www.largeluminoussurfaces.com

All rights are reserved. Reproduction in whole or in part is prohibited without the written consent of the copyright owner.
© KONINKLIJKE PHILIPS ELECTRONICS N.V. 2015

D1: wall hook

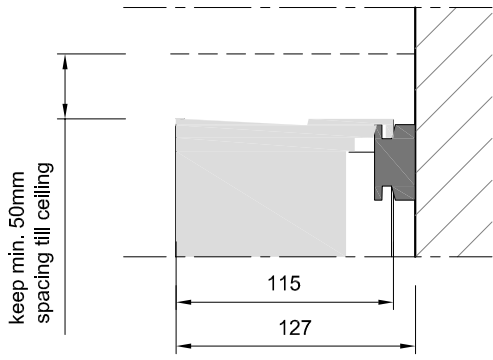

D2: magnet + plate

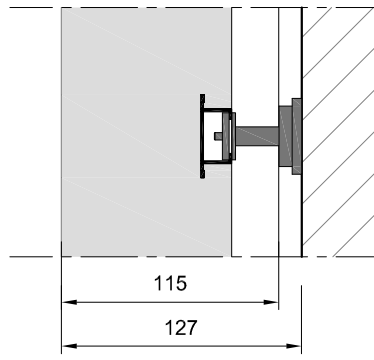

D3: magnet + L-bracket

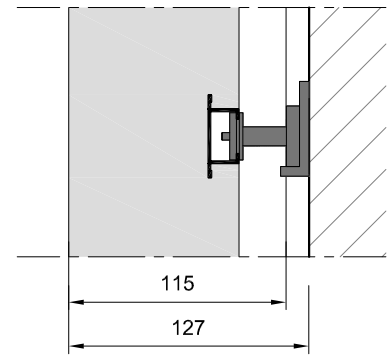

D4: recessed mounting - clearance

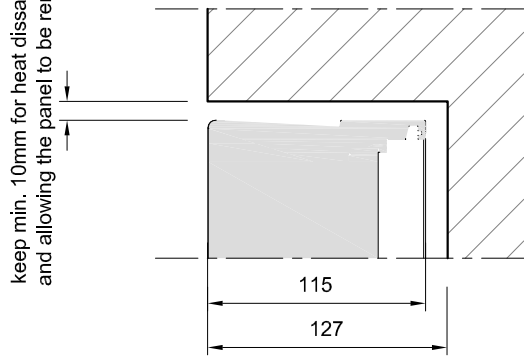

D5: wall hook / magnet + plate

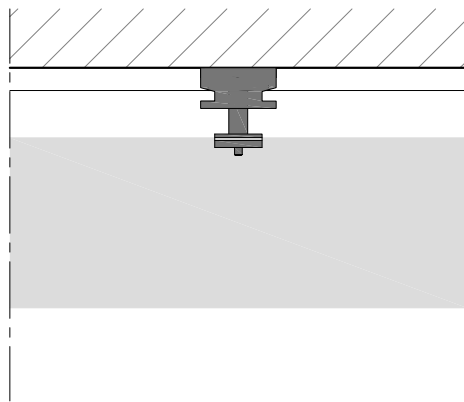

D6: magnet + plate / magnet + L-bracket

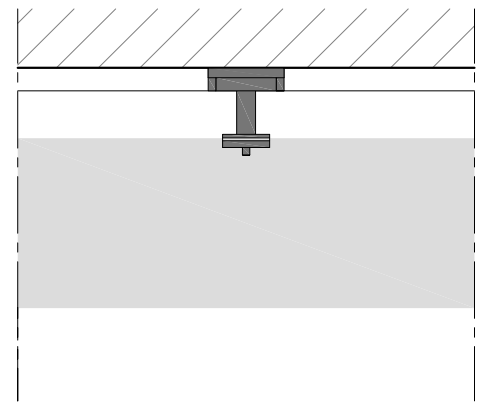

D7: safety eye

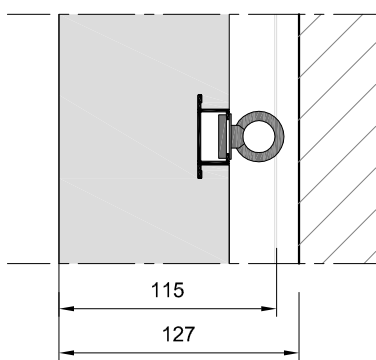

ensure wall safety eye is not exactly behind the panel safety eye

D8: magnet + plate / safety eye

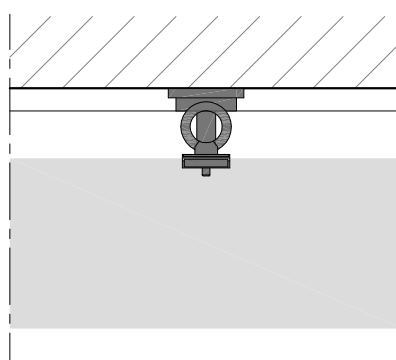

ensure ceiling safety eye is not exactly behind the panel safety eye

D9: technical suspended

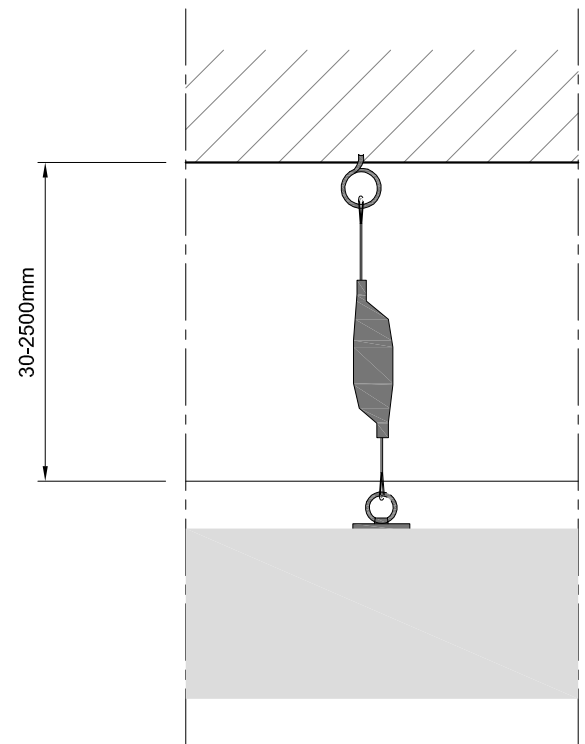

D10: posilock suspended

