

\*available space for mounting, cables, sockets etc. space not available behind driverbox and length crossbar

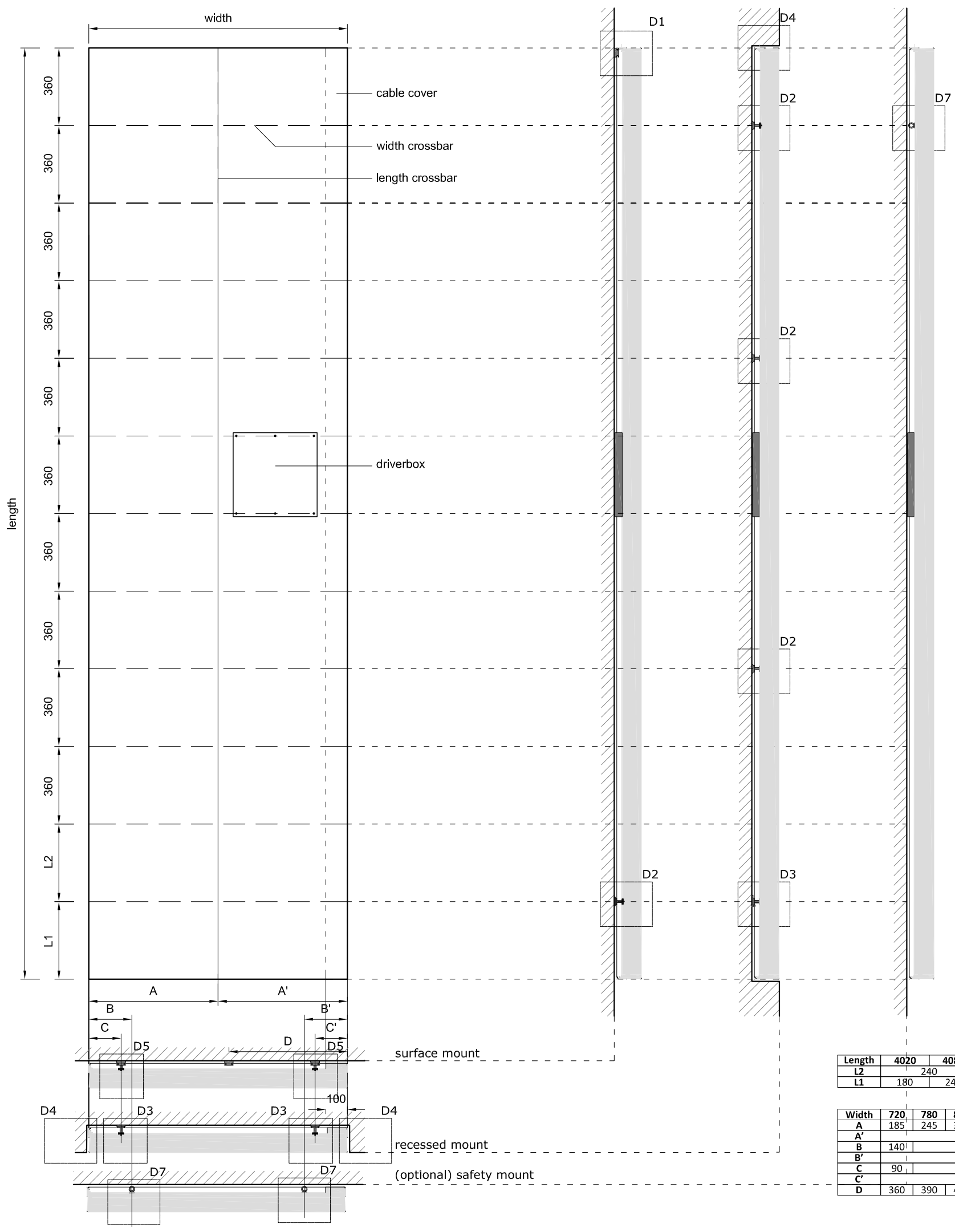

Length	4020	4080	4140	4200	4260	4320
L2	240					
L1	180	240	180	240	300	360

Width	720	780	840	900	960	1020	1080	1140	1200	
A	185	245	305	365	425	485	545	570	600	
A'	535									
B	140	200								
B'	200									
C	90	150								
C'	150									
D	360	390	420	450	480	485	495	520	550	

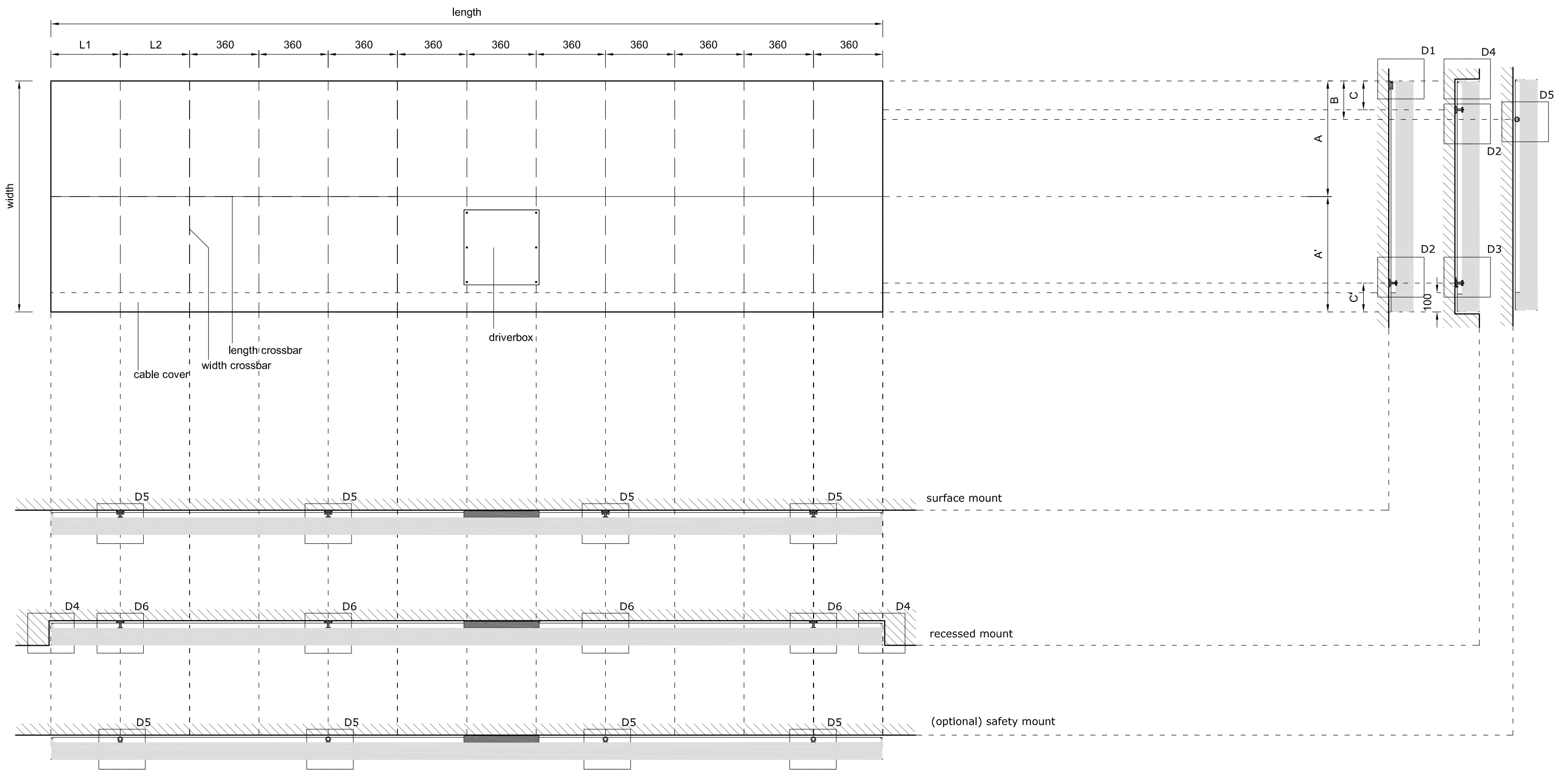

panel height

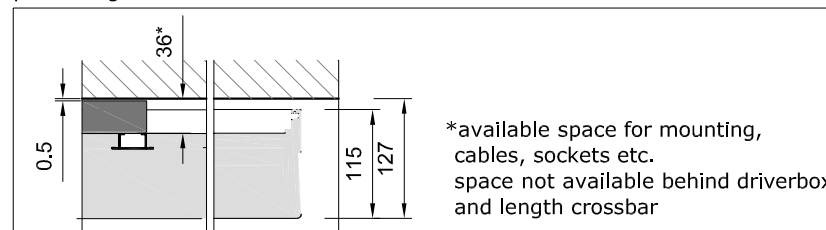

Length	4020	4080	4140	4200	4260	4320
L2	240			360		
L1	180	240	180	240	300	360

Width	720	780	840	900	960	1020	1080	1140	1200
A	185	245	305	365	425	485	545	570	600
A'				535				570	600
B	140				200				
B'					200				
C	90				150				
C'					150				
D	360	390	420	450	480	485	495	520	550

All rights are reserved. Reproduction in whole or in part is prohibited without the written consent of the copyright owner.  
© KONINKLIJKE PHILIPS ELECTRONICS N.V. 2015

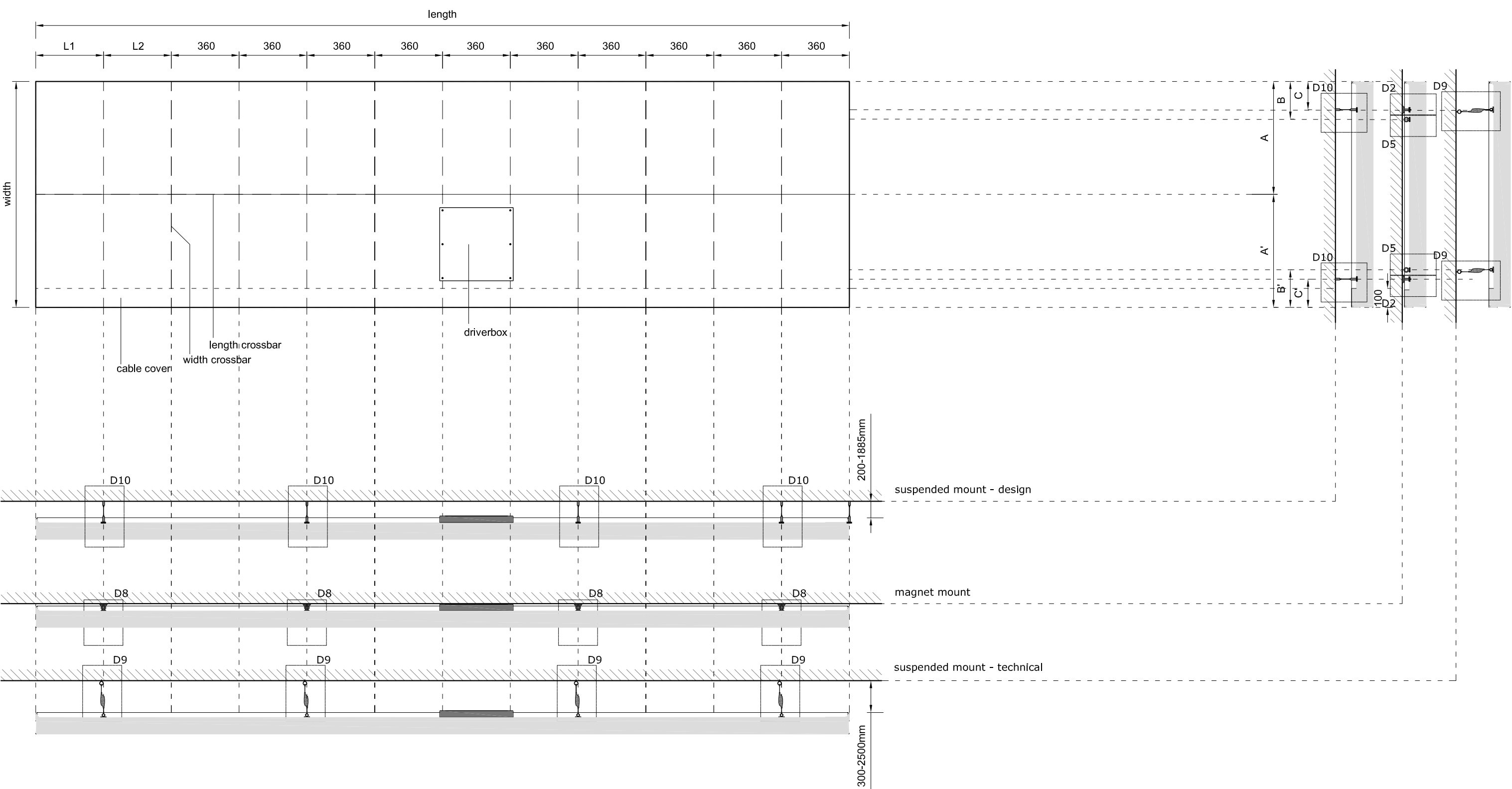

panel height

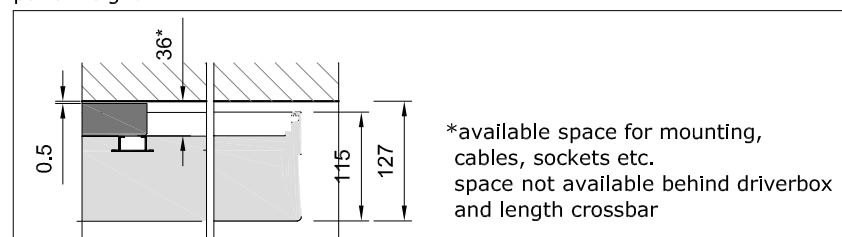

Length	4020	4080	4140	4200	4260	4320
L2	240			360		
L1	180	240	180	240	300	360

Width	720	780	840	900	960	1020	1080	1140	1200
A	185	245	305	365	425	485	545	570	600
A'				535				570	600
B	140				200				
B'				200					
C	90				150				
C'				150					
D	360	390	420	450	480	485	495	520	550

D1: wall hook

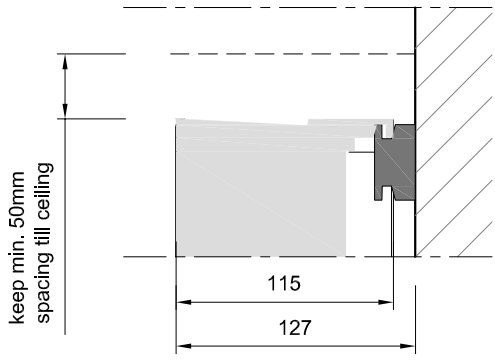

D2: magnet + plate

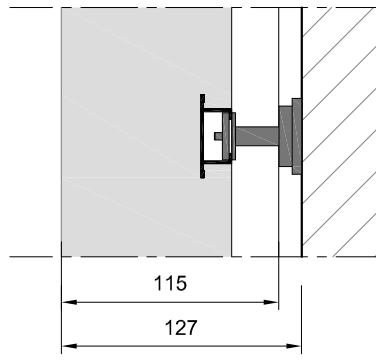

D3: magnet + L-bracket

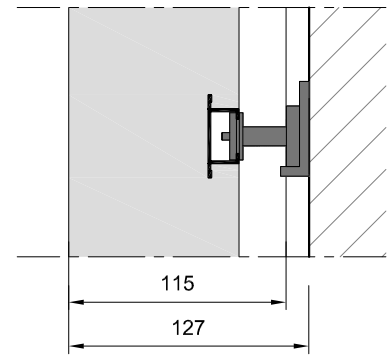

keep min. 10mm for heat dissipation and allowing the panel to be removed

D4: recessed mounting - clearance

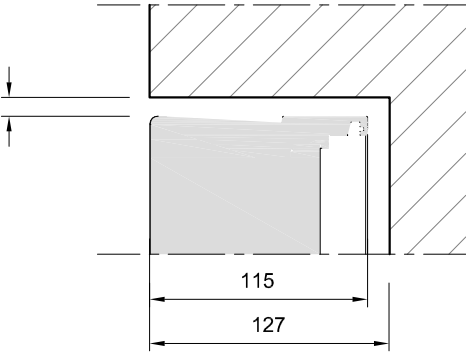

D5: wall hook / magnet + plate

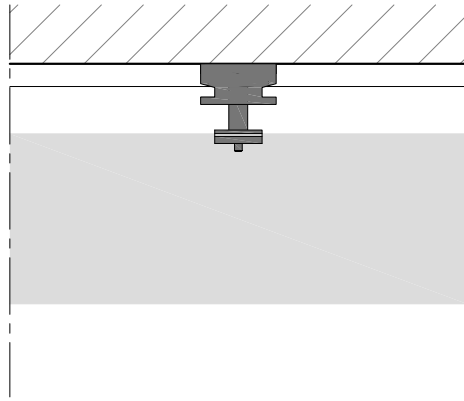

D6: magnet + plate / magnet + L-bracket

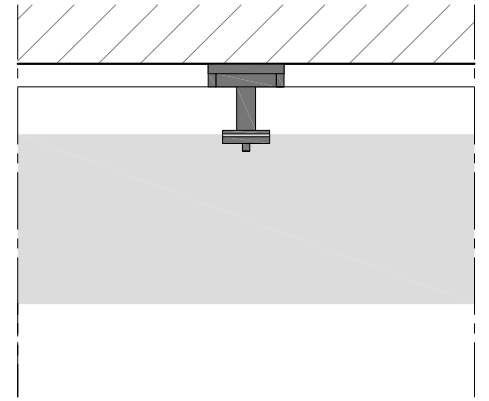

D7: safety eye

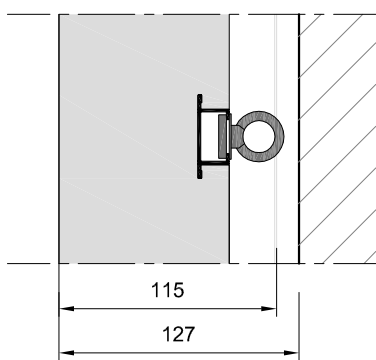

ensure wall safety eye is not exactly behind the panel safety eye

D8: magnet + plate / safety eye

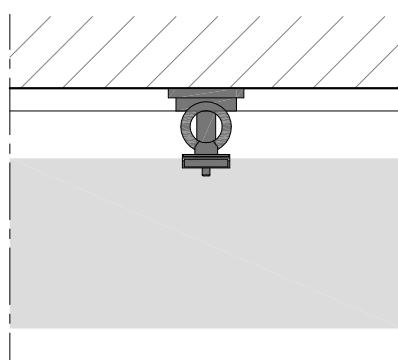

ensure ceiling safety eye is not exactly behind the panel safety eye

D9: technical suspended

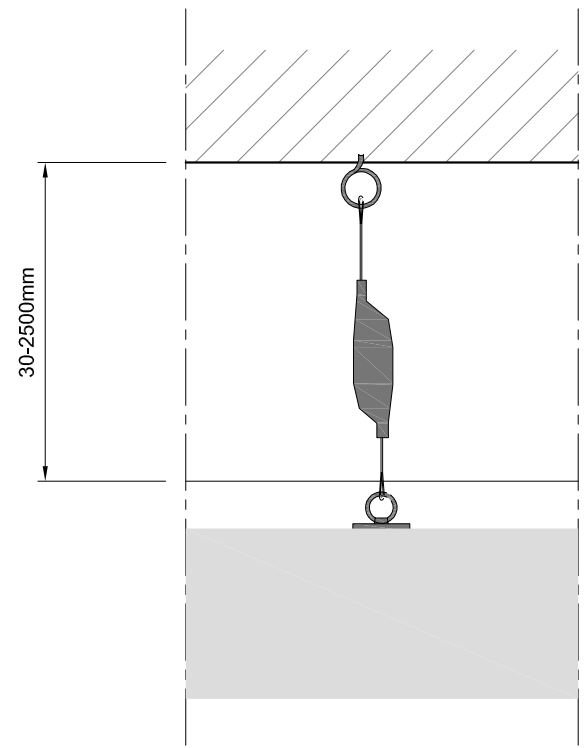

D10: posilock suspended

